



**ITEM: 1312K-1 Platform Headboard
1312K-2 Storage Footboard & Slats
1312-3 QN/EK Rails**

Thank you for purchasing this quality product. Be sure to check all packing material carefully for small parts which may have come loose inside the carton during shipment. Identify and count all parts and compare with the Parts List below.

! For items use on wooden floor, hard surfaces or carpets, it is recommended to Install protective pads under all legs and supports to avoid/ prevent from damages/ scratches and discoloration.





! Pour les articles Utilisés sur un plancher en bois, des surfaces dures ou tapis, il est recommandé d'installer des mordaches de protection sous tous les jambes et prend en charge pour éviter/empêcher de dommages/raures et la décoloration.

**HARDWARE LIST OF FOOTBOARD
HARDWARE PACK IS IN-1312K-2**





NO	DRAWING	DRESCRIPTION	Q'TY
5		#8*1" Screw	22Pcs

COMPONENT LIST		
A	HEADBOARD	1PC
B	HEADBOARD RSF LEG	1PC
C	HEADBOARD LSF LEG	1PC
D	FOOTBOARD	1PC
E	FOOTBOARD DRAWER	2PCS
F	SIDE RAIL	2PCS
G	SLAT (11PCS)	1SET
H	SLAT SUPPORT LEG LONG (32*32*382mm)	10PCS
I	SLAT SUPPORT LEG SHORT(32*32*113mm)	1PC

**HARDWARE LIST OF BED RAIL
HARDWARE PACK IS IN-1312-3**

NO	DRAWING	DRESCRIPTION	Q'TY
6		Ø5/16"-18*3-1/2" Hanger Bolt	8Pcs
7		Ø50 Arc Washer	8Pcs
8		Ø5/16"*L17 Nut	8Pcs
9		Ø5/16" Open Wrench	1Pc

**HARDWARE LIST OF HEADBOARD
HARDWARE PACK IS IN-1312K-1**

NO.	DRAWING	DESCRIPTION	Q'TY
1		Ø5/16"-18*1-1/2" Bolt	6Pcs
2		Ø50 Lock Washer	6Pcs
3		Ø5/16"*19*2mm Flat Washer	6Pcs
4		Ø5/16" Allen Key	1Pc



**ITEM: 1312K-1 Platform Headboard
1312K-2 Storage Footboard & Slats
1312-3 QN/EK Rails**

Thank you for purchasing this quality product. Be sure to check all packing material carefully for small parts which may have come loose inside the carton during shipment. Identify and count all parts and compare with the Parts List below.

! For items use on wooden floor, hard surfaces or carpets, it is recommended to Install protective pads under all legs and supports to avoid/ prevent from damages/ scratches and discoloration.

! Pour les articles Utilisés sur un plancher en bois, des surfaces dures ou tapis, il est recommandé d'installer des mordaches de protection sous tous les jambes et prend en charge pour éviter/empêcher de dommages/raures et la décoloration.

! This device complies with Part 15 of the FCC Rules. Operation is subject to the following two conditions: (1) This device may not cause harmful interference. and(2) this device must accept any interference received, including interference that may cause undesired operation.

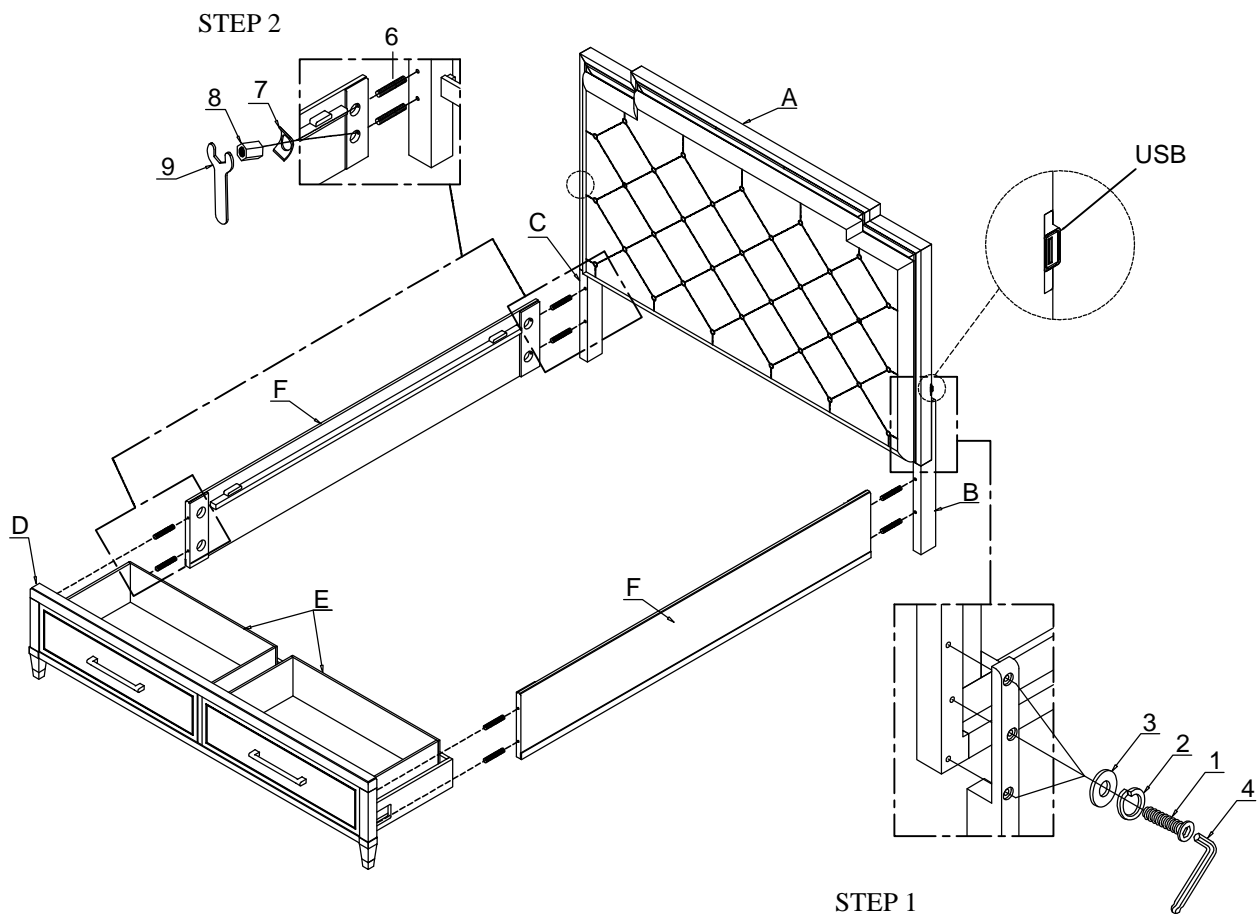



ITEM: 1312K-1 Platform Headboard
1312K-2 Storage Footboard & Slats
1312-3 QN/EK Rails

Thank you for purchasing this quality product. Be sure to check all packing material carefully for small parts which may have come loose inside the carton during shipment. Identify and count all parts and compare with the Parts List below.

! For items use on wooden floor, hard surfaces or carpets, it is recommended to install protective pads under all legs and supports to avoid/ prevent from damages/ scratches and discoloration.

! Pour les articles Utilisés sur un plancher en bois, des surfaces dures ou tapis, il est recommandé d'installer des mordaches de protection sous tous les jambes et prend en charge pour éviter/empêcher de dommages/raures et la décoloration.

STEP 5

