



H O M E E L E G A N C E



ASSEMBLY INSTRUCTION

ITEM NO.: 9004BRW/GRY-1LT

Power Lift Chair

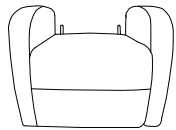
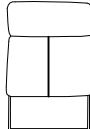

NOTE: Do not use power tools for assembly. Power tools increase the risk of over tightening which leads to splitting or cracking the wood.

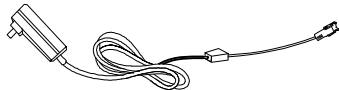
NO.	DRAWING	DESCRIPTION	QTY
A		Seat	1 PC
B		Backrest	1 PC
C		Controller	1 PC
D		Chair Adaptor	1 PC

STEP 1:

Chair adaptor and controller are stored in the bottom

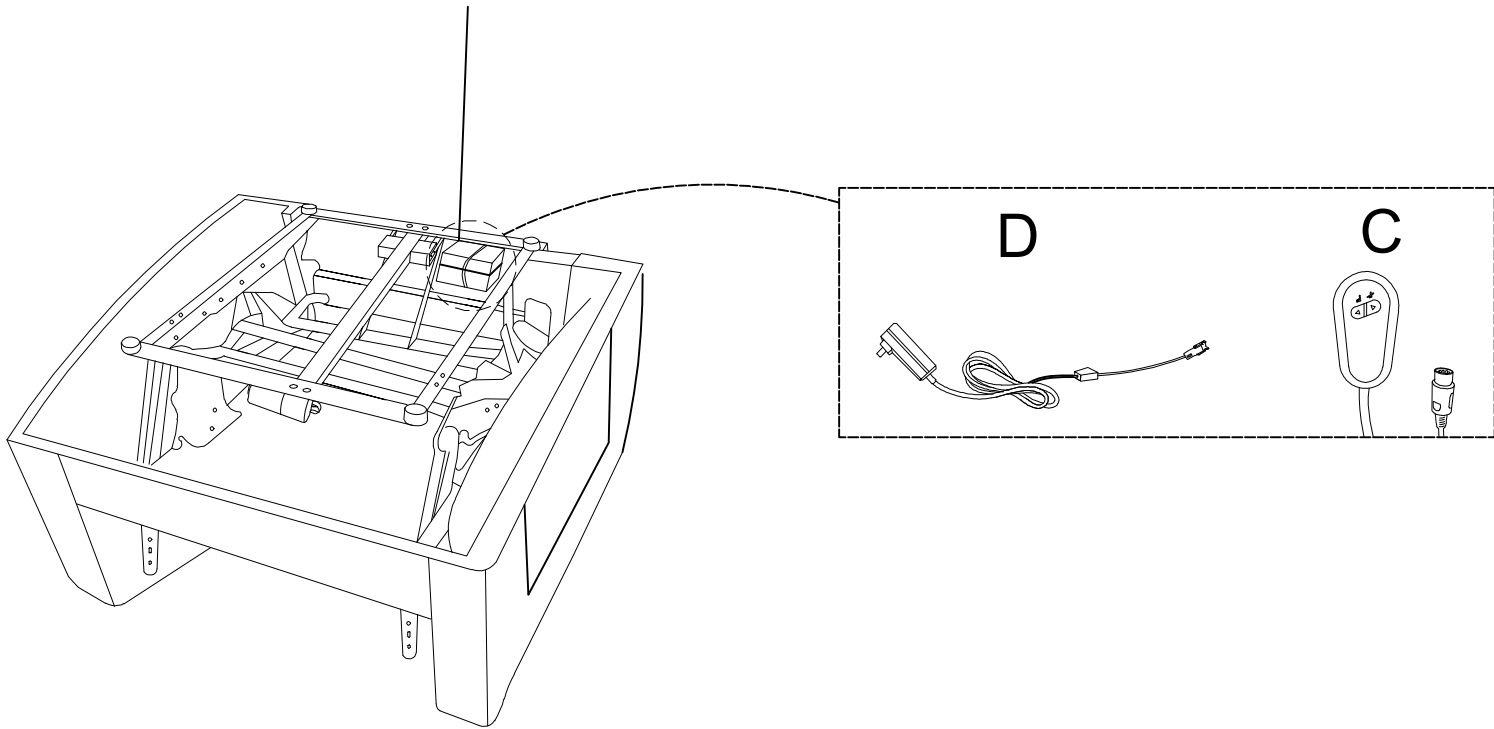

STEP 2:

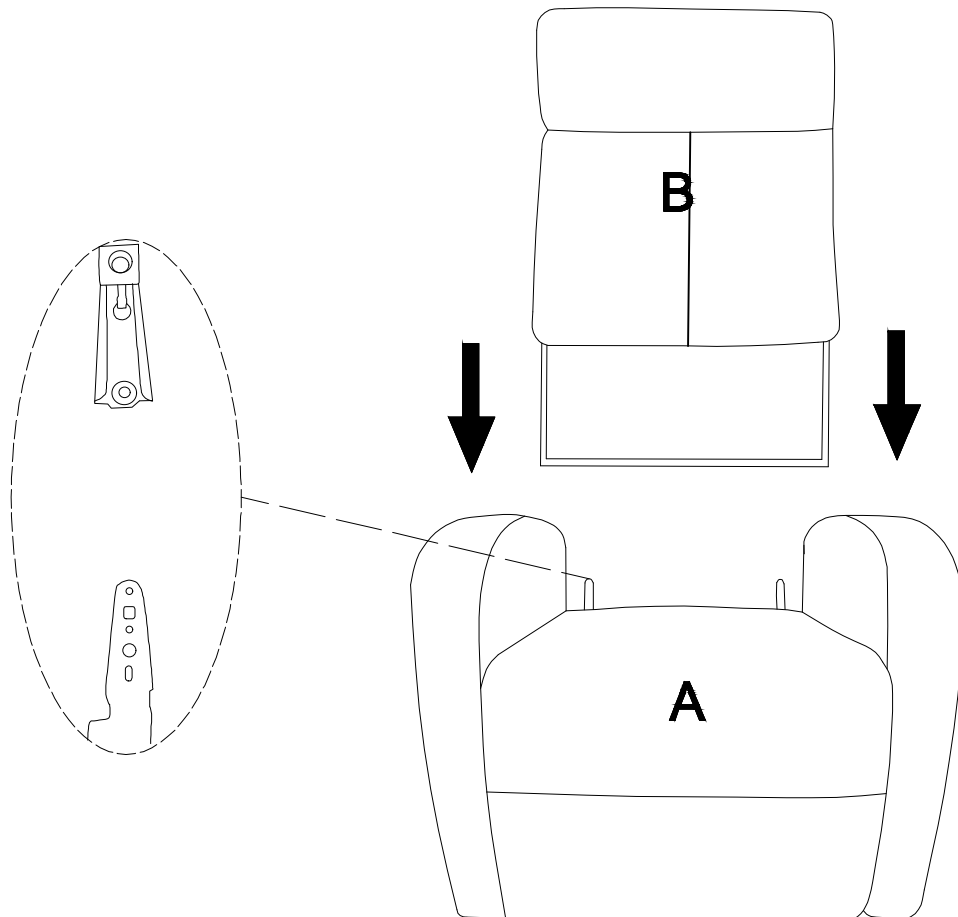

STEP 3:

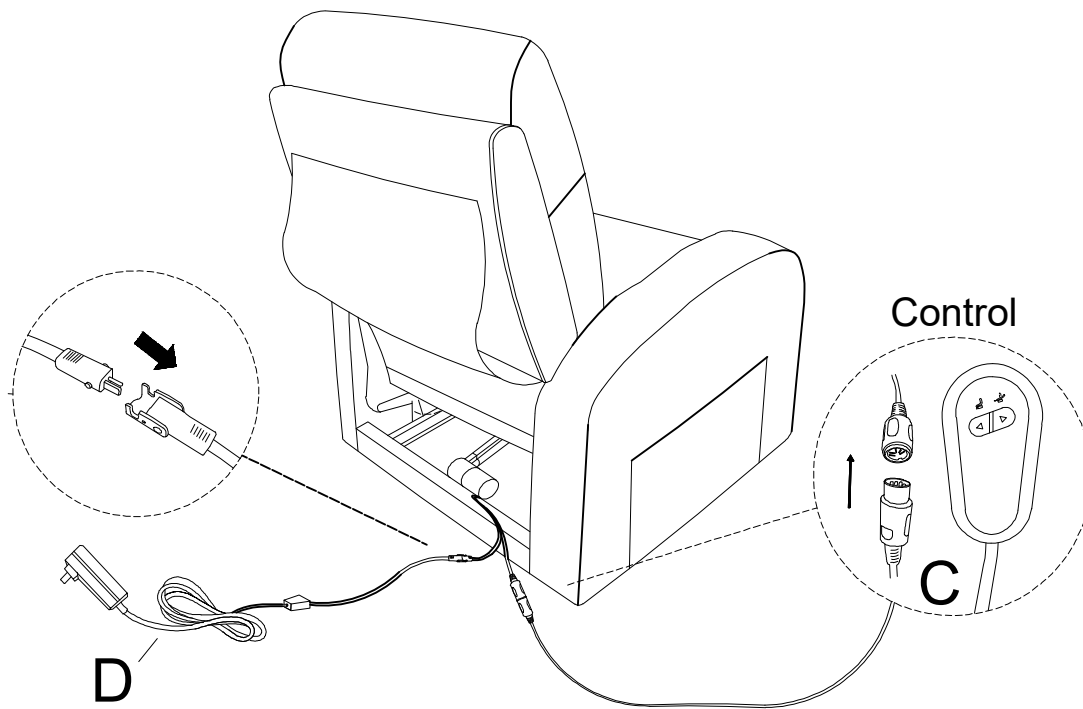

STEP 4:

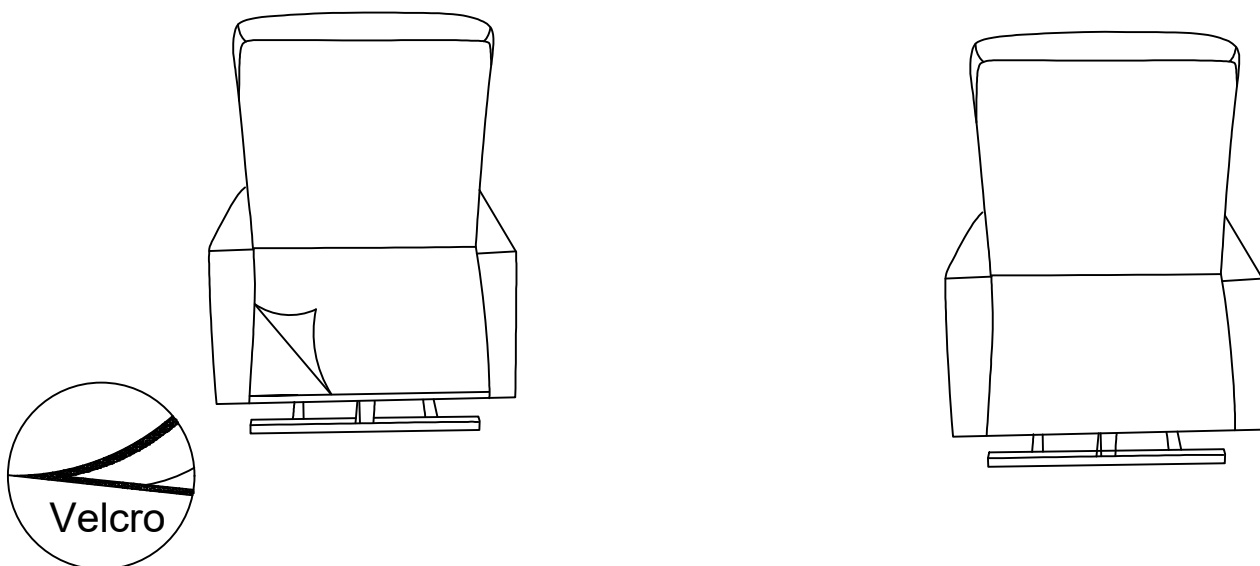

LIFT

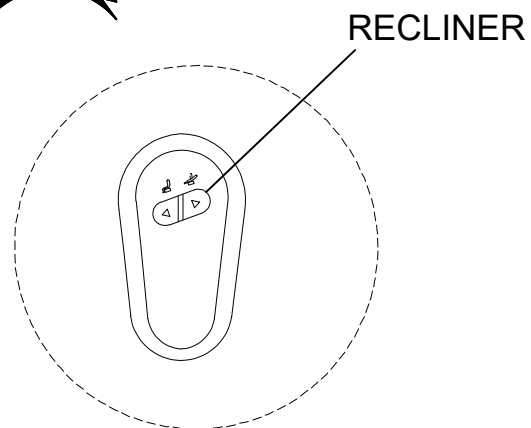
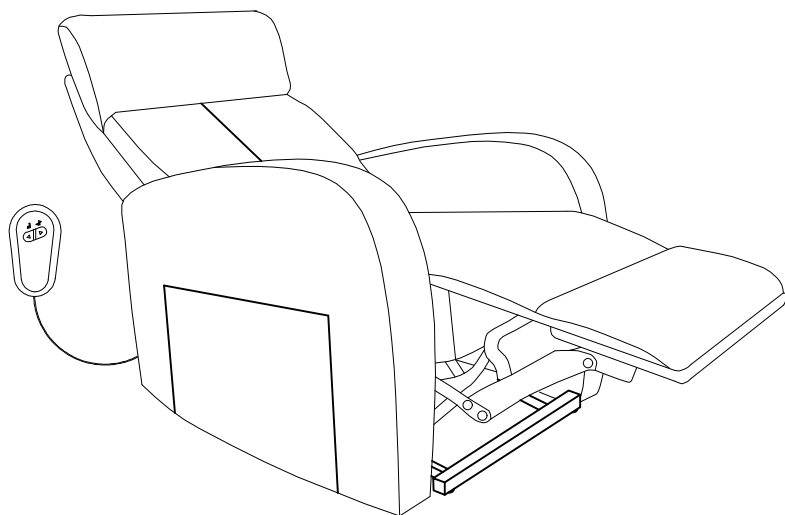
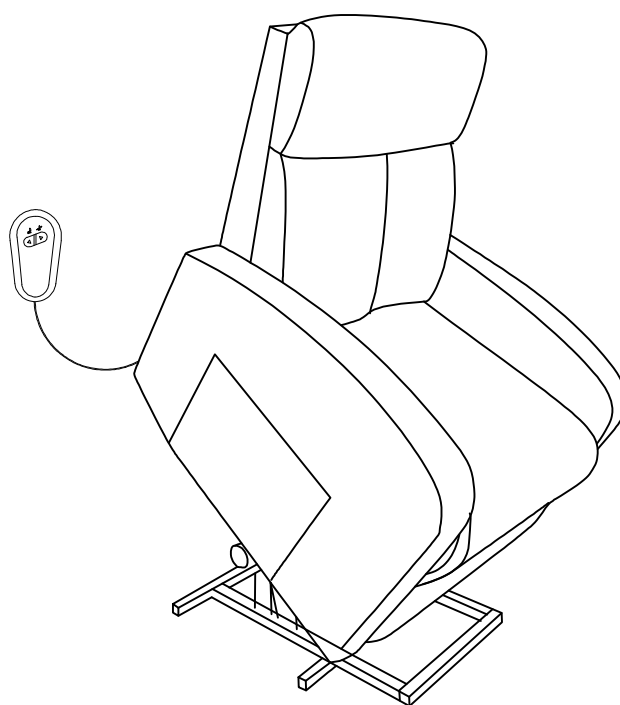
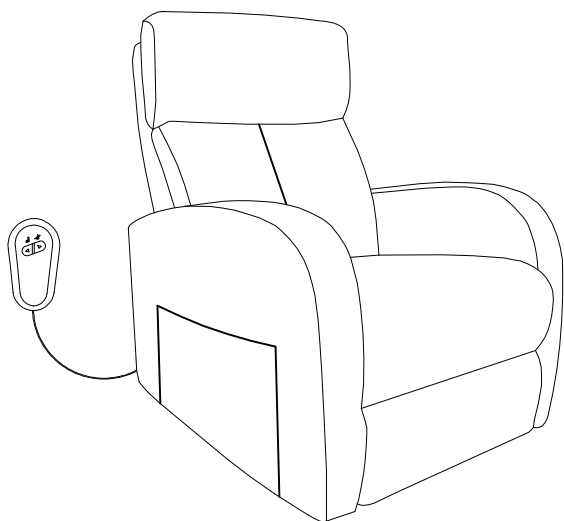
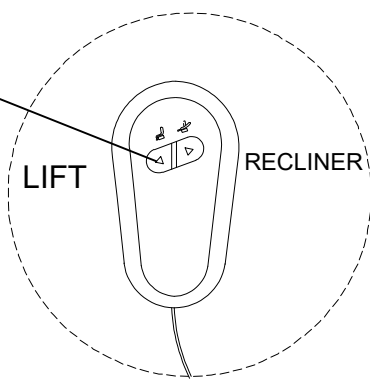

COMPLETED

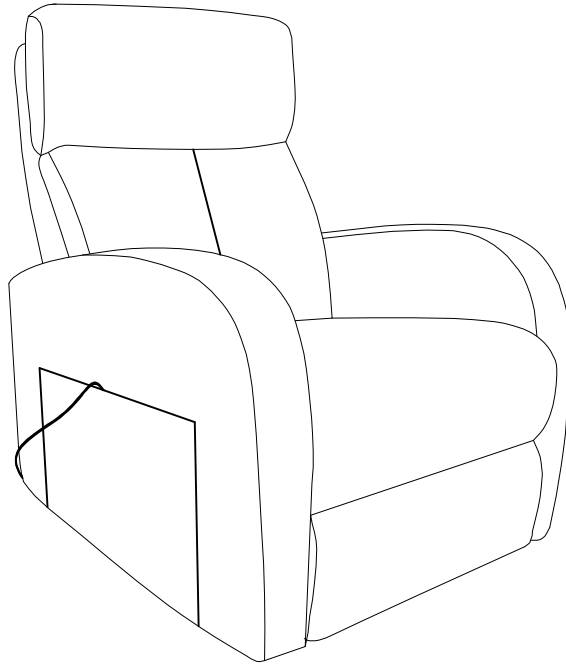

Care Instructions for Textured Microfiber Furniture:

In order to maintain the original appearance of your textured microfiber furniture, please follow the simple care procedures below:

- **Avoid exposing furniture directly to sunlight or heating and air conditioning outlets. Sunlight and/or exposure to heating and air conditioning outlets will fade/damage textured microfiber .**
- **Vacuum or wipe with a soft cloth to remove dust.**
- **Hardware may loosen over time. Periodically check to make sure all connection are tight. Re-tighten if necessary.**



For items used on wooden floor, hard surfaces or carpets, it is recommended to install protective pads under all legs and supports to prevent damages, scratches and discoloration.