

ASSEMBLY INSTRUCTION

H11765&H11765B FLOOR LAMP

No special tools are needed to install this floor lamp. Be sure to follow the steps in assembly instruction given. If you are unclear for how to proceed, consult a qualified electrician.

IMPORTANT SAFETY INSTRUCTION :

- To prevent shock, only plug in unit after completed assembly.
- Do not exceed the maximum wattage rating as suggested.
- Before switch on the lamp, please follow the instruction step by step.
- Do not recommend to keep on the light exceed 12 hours.
- Replace the bulb when the glass tube and base is completely cold.
- This product is intended for indoor use only and should be positioned in a dry location and away from sunlight.
- Please keep away from children and pets to prevent breakage from fall or tip over.

Note : this floor lamp has a polarized plug(one blade is wider than the other). As a safety feature, this plug will fit in a polarized outlet only in one way. If the plug does not fit fully in the outlet, reverse the plug. If it still does not fit, contact a qualified electrician. Never use with an extension cord unless plug can be fully inserted. Do not modify or change from the original lamp polarized plug to fit to different outlet.

Step1:Take out the floor lamp and shades from the package slowly. Place the floor lamp on smooth and level surface.

Step 2:Align and insert the glass tube to the top of metal tube(Figure 1).

Step3: Push the glass tube up and slip the two sleeves onto the bottom of the glass tube(Figure 2).

Step4: Push down the two sleeves onto the bottom of the lamp(Figure 3).

Step 5:Release the plastic ring from the holder.

Step 6:Place the glass shade onto the holder.

Step7: Rotate to tighten the plastic ring onto the top of the shade(Figure 4).





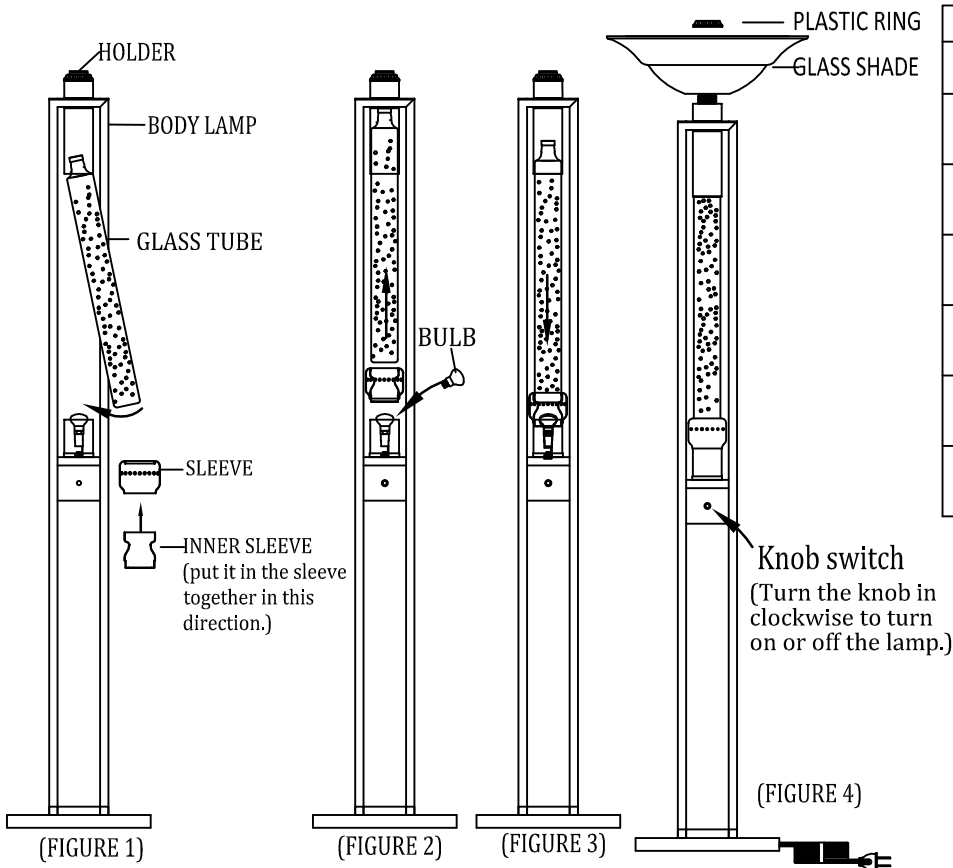

Step8: Day light: Do not exceed maximum 100watt or 23 watt for energy saving UL listed bulbs.

Only replace LED bulbs with proper wattage as assigned from the bulb packing.

Step9: Night light: Do not exceed maximum 25 watt UL listed bulbs,It is not compatible to replace with LED bulbs.

Step10:Insert the polarized plug to the proper outlet.



PARTS LIST			
NO.	DRAWING	QTY	DESCRIPTION
1		1	BODY LAMP
2		1	GLASS TUBE
3		1	SLEEVE
4		1	INNER SLEEVE
5		3	BULB (TYPE R、E17)
6		1	GLASS SHADE

How to replace the light bulb :
Switch off the lamp and unplug it.Wait until the glass tube cool completely, pull up the two sleeves and the glass tube(Figure2), align and rotate the bulb to install and tighten to the socket(Figure 3), push down the two sleeves onto the bottom of the lamp(Figure 4).

Care Instruction

To clean the lamp, wipe with a soft cloth. Do not use abrasive materials such as chemical pad, paper or cleaner.