

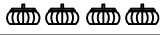





Assembly Instruction

ITEM#: 1468-5 DRESSER
1468-6 MIRROR





PART LIST

| | | |
|---|--------------------------------------------------------------------------------------------|-------|
| 1 | DRESSER | 1 PC |
| 2 | BUN FOOT  | 4 PCS |
| 3 | MIRROR | 1 PC |
| 4 | MIRROR SUPPORT | 2 PCS |

ANTI-TIPPING HARDWARE PACK IN-5

| | | | |
|---|------------------------------------------------------------------------------------|----------------------|-------|
| A |  | BRACKET | 2 PCS |
| B |  | TIE WRAP | 1 PC |
| C |  | LONG SCREW #8x2"L | 1 PC |
| D |  | SHORT SCREW #8x5/8"L | 1 PC |

HARDWARE LIST IN-M

| | | | |
|---|------------------------------------------------------------------------------------|----------------------------------------|-------|
| E |  | LONG BOLT $\varnothing 5/16$ "x2" | 4 PCS |
| F |  | SHORT BOLT $\varnothing 5/16$ "x1-1/2" | 4 PCS |
| G |  | FLAT WASHER 5/16" | 8 PCS |
| H |  | SPRING WASHER 5/16" | 8 PCS |
| I |  | ALLEN KEY 5/16" | 1 PC |

STEP 1

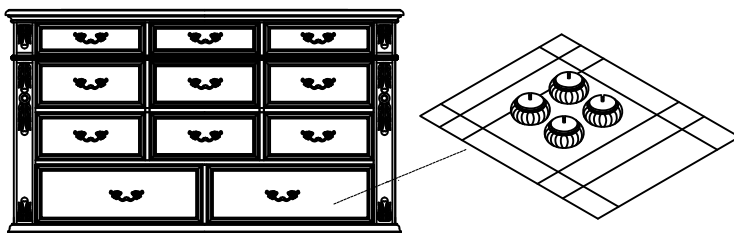

STEP 2

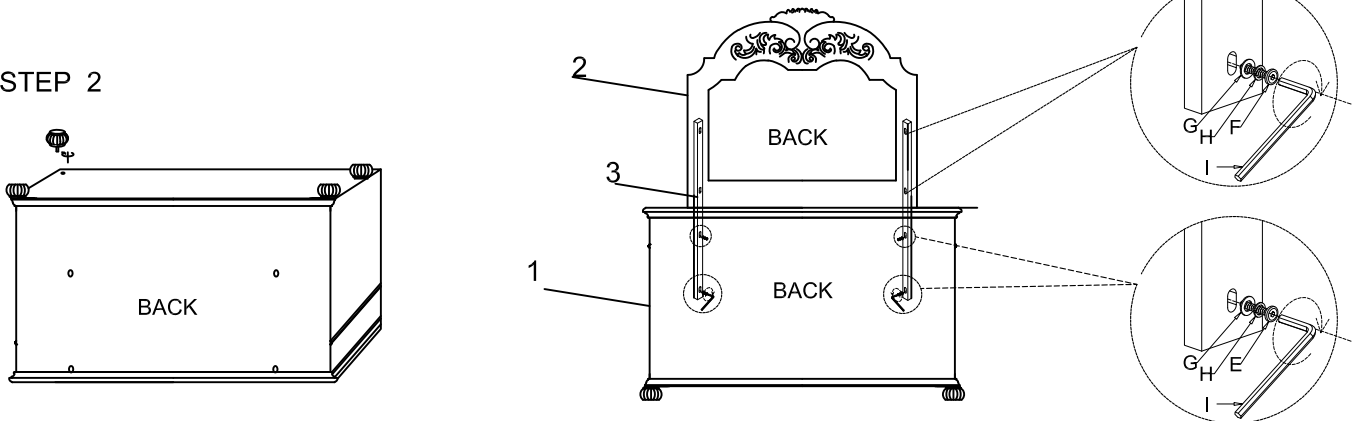

STEP 3

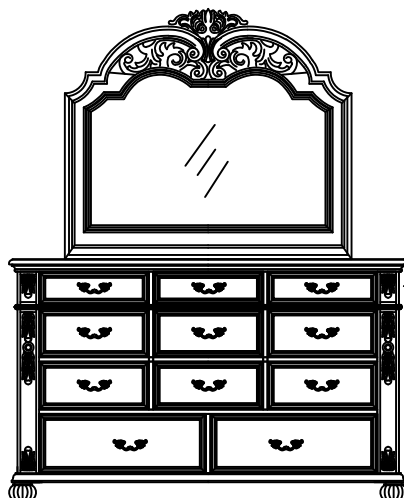

-REMOVE ANTI-TIPPING PACK FROM BACK PANEL. ASSEMBLE IT TO AVOID TIPPING.

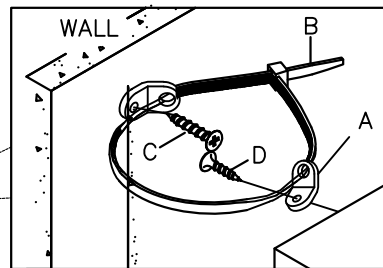

Assembly completed



- For items use on wooden floor hard surfaces or carpets. It is recommended to install protective pads under all legs and supports to avoid/prevent from damages/scratches and discoloration.
- Hardware may loosen over time. Periodically check to make sure all connections are tight. Re-tight if necessary.