



ASSEMBLY INSTRUCTION / INSTRUCTION D'ASSEMBLAGE

Item No : 1845-4 / 1845-4N

Description : Night Stand / Table De Nuit

! Thank you for purchasing this product. Please take time to read and follow the instructions below. Check that you have all parts and hardware before assembly. Parts apparently missing are often found in the packing materials. If you do not have all the parts listed, have your dealer contact us and they will be sent to you immediately.

Merci d'avoir acheté ce produit. Veuillez lire et suivre les instructions ci-dessous. Vérifiez avant le montage que vous avez toutes les pièces et fixations. Les pièces qui semblent manquer se trouvent souvent dans les matériaux d'emballage. Si vous n'avez pas toutes les pièces de la liste, demandez à votre détaillant et nous les enverrons immédiatement.

! It is recommended to install protective pads under all legs and supports to avoid damage or scratches when placing furniture on a wood floor or other hard surface, and to limit indentation and prevent discoloration if placing on carpet.

Il est recommandé de placer des coussins protecteurs sous tous les pieds et toutes les bases des meubles pour éviter d'endommager ou d'égratigner les planchers en bois ou autres surfaces dures, et pour limiter l'empreinte et empêcher la décoloration quand les meubles reposent sur la moquette.

! Hardware may loosen over time. Periodically check to make sure all connections are tight. Re-tighten if necessary.

Le matériel peut se desserrer au fil du temps. Vérifiez périodiquement que toutes les connexions sont serrées. Serrer à nouveau si nécessaire.

! DO NOT TIGHTEN BOLTS UNTIL COMPLETELY ASSEMBLED.

NE PAS SERRER LES BOULONS JUSQU'À CE QUE LE MONTAGE SOIT COMPLETMENT TERMINE.

PART LIST / LISTE DE PIÈCES

NO	NAME	PART	QTY
A	Night Stand / Table De Nuit		1pc

HARDWARE LIST / LISTE DE QUINCAILLERIE

NO	NAME	PART	QTY
B	Bun-foot / Pied		4pcs

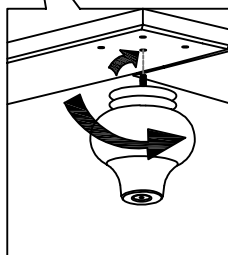
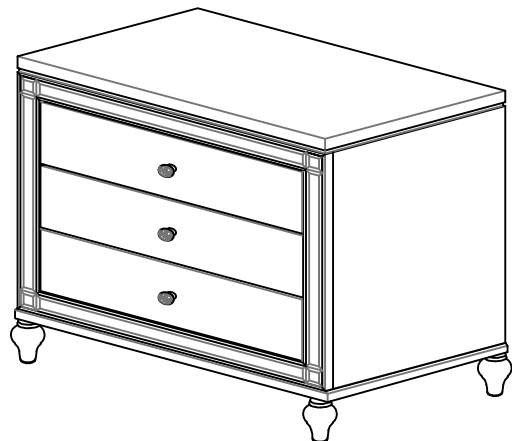
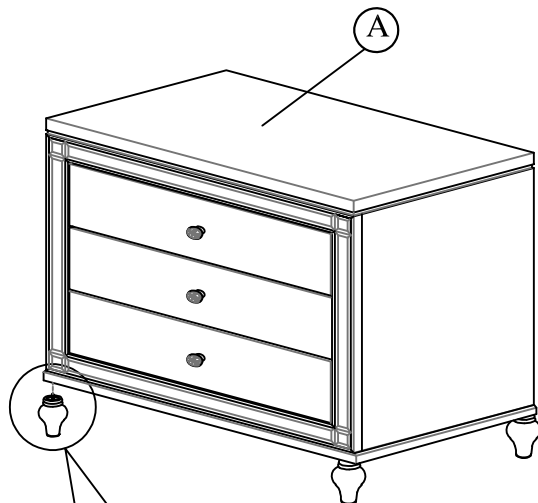

Step 1 / Etape 1 : Secure the bun-foot as shown in the diagram.

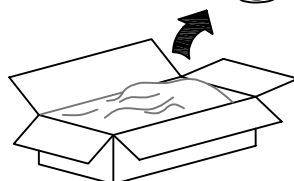
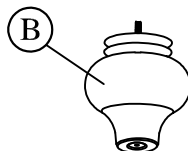

Take out the bun-foot from the carton box that can be found at the drawer box of casegood.







ASSEMBLY INSTRUCTION / INSTRUCTION D'ASSEMBLAGE

Item No : 1845-4 / 1845-4N

Description : Night Stand / Table De Nuit

HARDWARE LIST / LISTE DE QUINCAILLERIE

NO	NAME	PART	QTY
E1	Bracket / Equerre		2pcs
E2	Tie Wrap / Attache A Tete D'equerre		1pc
E3	Long Screw / Vis Longue		1pc
E4	Short Screw / Vis Courte		1pc

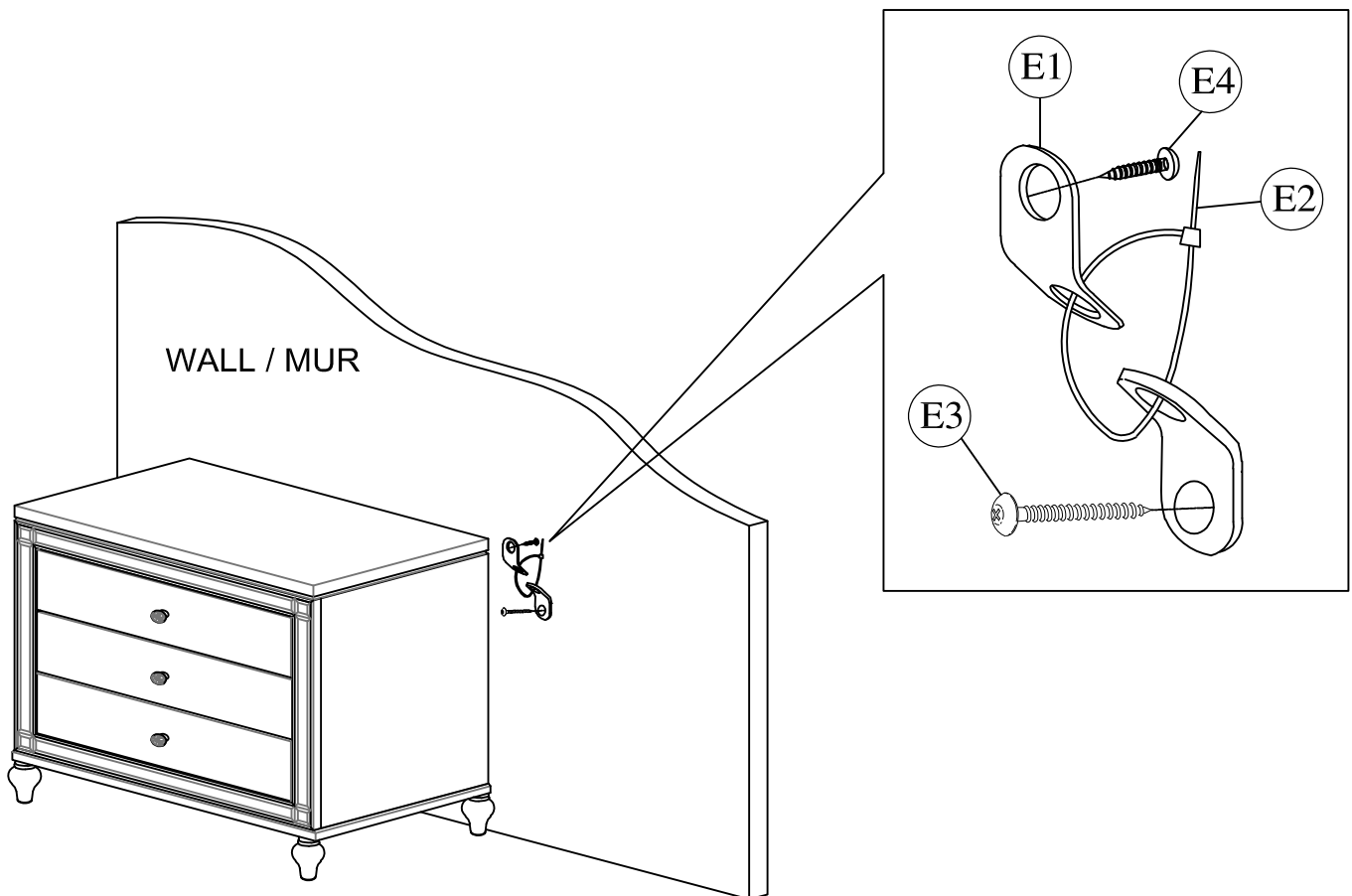

NOTE / REMARQUE

Tipping Restraint hardware kit is included with this product. Refer to installation instruction in the hardware pack.

Une trousse anti-basculement est fourni avec ce produit. Veuillez vous référer aux instructions d'installation dans inclu dans la trousse de quincaillerie

*ANTI-TIPPING HARDWARE PACK IS AT THE BACK PANEL

*UNE TROUSSE ANTI-BASCULEMENT EST SITUÉ SUR LE PANNEAU ARRIÈRE.

Page: 2 of 2

Revision 02 APR 2024

Made In Malaysia / Fabriqué en Malaisie