

ASSEMBLY INSTRUCTIONS / INSTRUCTIONS D'ASSEMBLAGE

5682 GRY / BLK / BRW / GEN / RED - 29 - 3A









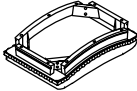

COUNTER HEIGHT STOOL TABOURETS DE COMPTOIR

Thank you for purchasing this product. Please take time to read and follow the instructions below. Check that you have all parts and hardware before assembly. Parts apparently missing are often found in the packing materials. If you do not have all the parts listed, have your dealer contact us and they will be sent to you immediately.

 It is recommended to install protective pads under all legs and supports to avoid damage or scratches when placing furniture on or other hard surface, and to limit indentation and prevent discoloration if placing on carpet.

Merçi d'avoir acheté ce produit de qualité. Vérifiez avant le montage que vous avez toutes les pièces et fixations. Les pièces qui semblent manquer se trouvent souvent dans les matériaux d'emballage. Si vous n'avez pas toutes les pièces de la liste, demandez à votre détaillant et nous vous les enverrons immédiatement.

 Il est recommandé de placer des coussins protecteurs sous tous les pieds et toutes les bases des meubles pour éviter l'endommagement ou d'égratigner les planchers en bois ou autres surfaces dures, et pour limiter l'empreinte et empêcher la décoloration quand les meubles reposent sur la moquette.

PART LIST / LISTE DE PIÈCES				HARDWARE LIST / LISTE DE QUINCAILLERIE			
A		Seat Cushion / Siège Coussiné	1	1		Lock Washers / Rondelle D'arrêt 5/16" x 6/8" x 3/32"	8
B(L)		Left Leg / Gauche Pied	2	2		Flat Washers / Rondelle Plate 5/16" x 6/8" x 3/32"	8
B(R)		Right Leg / Droit Pied	2	3		Bolts / Boulon 5/16" x 2-5/32"	8
C		Long Stretcher / Entrejambe Longue	2	4		Allen key / Clé Allen 5/32"	1
D		Short Stretcher / Entrejambe Court	2	5		Wood Screws / Vis #4 x 1-1/2"	8

HARDWARE SET ARE PACKED IN 5682 GRY / BLK / BRW / GEN / RED - 29 - 3A FOR ASSEMBLY

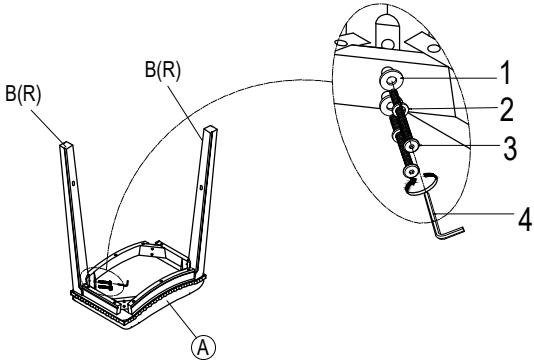
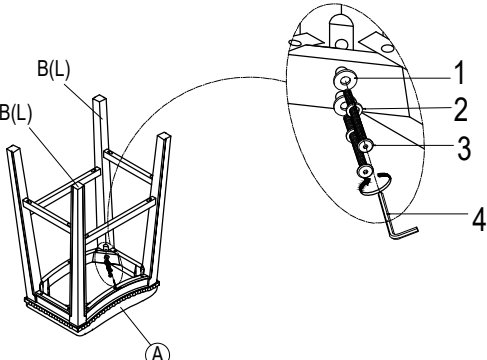
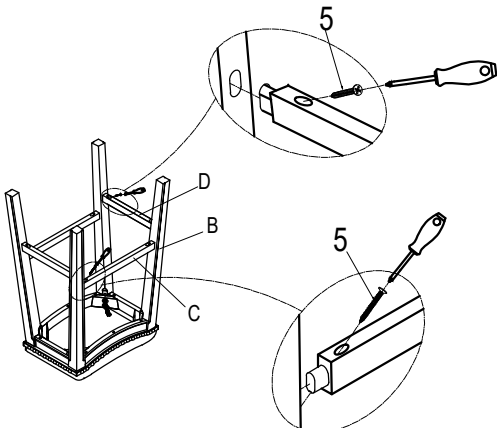
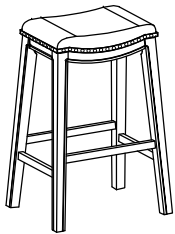
<p>STEP 1 / ÉTAPE 1</p> 	<p>STEP 2 / ÉTAPE 2</p> 
<p>STEP 3 / ÉTAPE 3</p> 	<p>ASSEMBLY COMPLETED / ASSEMBLAGE COMPLÉTÉ</p> 

DO NOT TIGHTEN BOLTS UNTIL COMPLETELY ASSEMBLED

NE PAS SERRER LES BOULONS JUSQU'À CE QUE LE MONTAGE SOIT COMPLÈTTERMINÉ

MADE IN VIETNAM / FABRIQUÉ AU VIETNAM

PAGE 1 OF 1