

ASSEMBLING INSTRUCTIONS

ITEM NO: 9916DG-LL/9916GY-LL







(1/2) LEFT SIDE 2-SEATER WITH PULL-OUT BED

9916DG-RC/9916GY-RC



(2/2) RIGHT SIDE CHAISE WITH HIDDEN STORAGE

⚠ It is recommended to install protective pads under all legs and supports to avoid damage or scratches when placing furniture on a wood floor or other hard surface, and to limit indentation and prevent discoloration if placing on carpet.

PARTS LIST - RC

NO.	DRAWING	QTY	DESCRIPTION
A		1 PC	RIGHT SIDE CHAISE
B		1 PC	CHAISE BACK REST
C		1 PC	BACK CUSHION
D		2 PCS	PILLOW 16"*16"*6-1/2"
E		4 PCS	WOODEN LEG 4.5"*3-1/7"*2"
F		1 PC	WOODEN LEG 3-1/7"*3-1/7"*2"
G		10 PCS	SCREW M5*2"

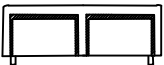
PARTS LIST - LL

NO.	DRAWING	QTY	DESCRIPTION
H		1 PC	LEFT SIDE 2-SEATER (leg pre-assembled)
I		1 PC	2 SEATER BACK REST
J		2 PCS	BACK CUSHION

STEP 1: - RC

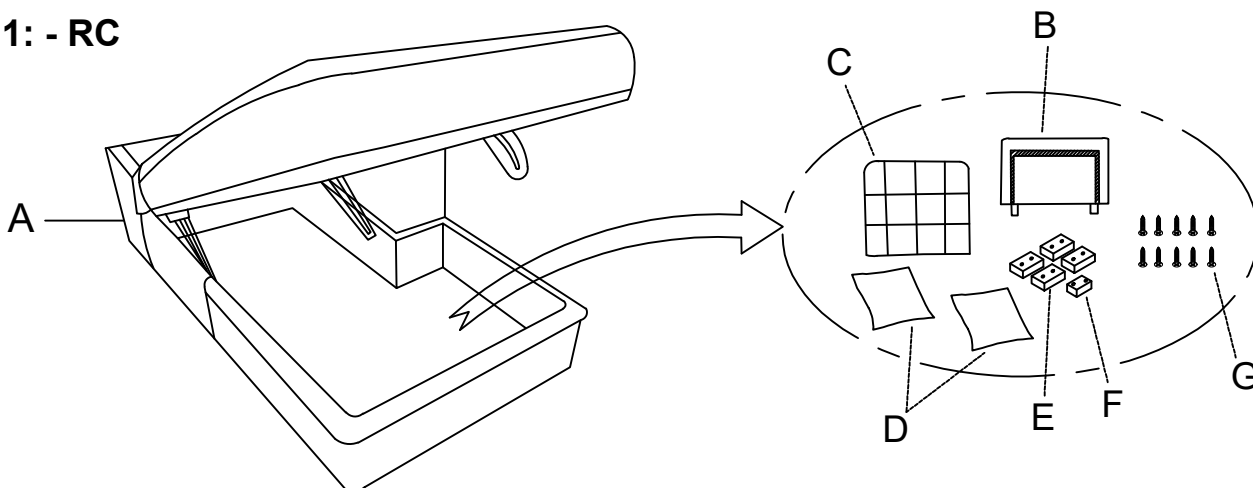

ASSEMBLING INSTRUCTIONS

ITEM NO: 9916DG-LL/9916GY-LL

(1/2) LEFT SIDE 2-SEATER WITH PULL-OUT BED

9916DG-RC/9916GY-RC

(2/2) RIGHT SIDE CHAISE WITH HIDDEN STORAGE

STEP 2:

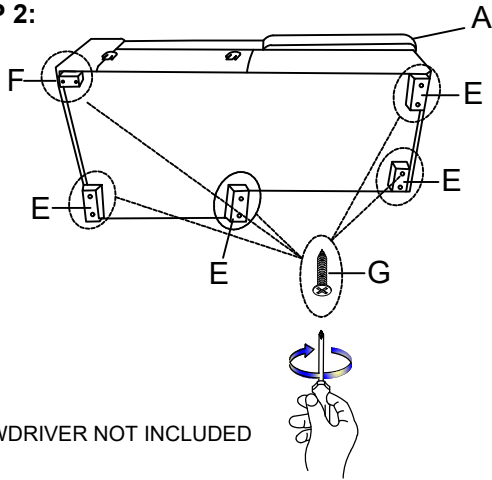

SCREWDRIVER NOT INCLUDED

STEP 3:

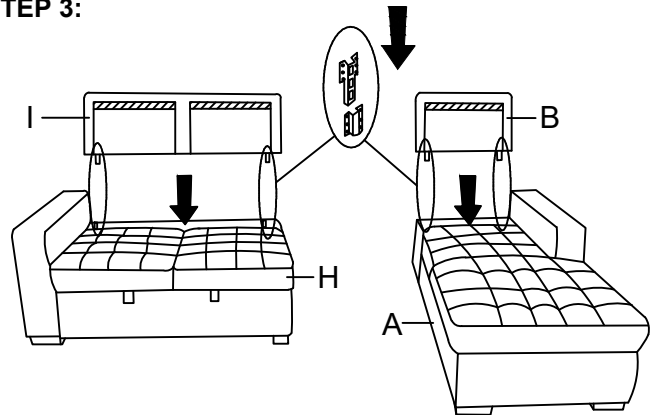

STEP 4:

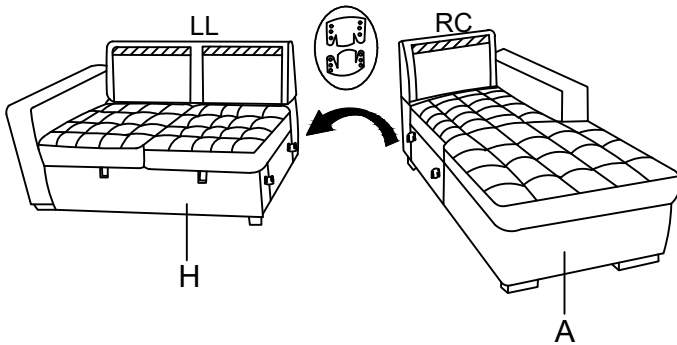

STEP 5:

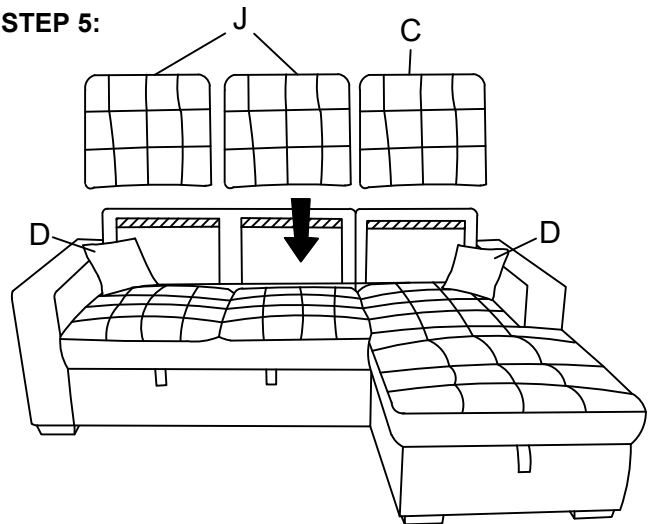

STEP 6: COMPLETED

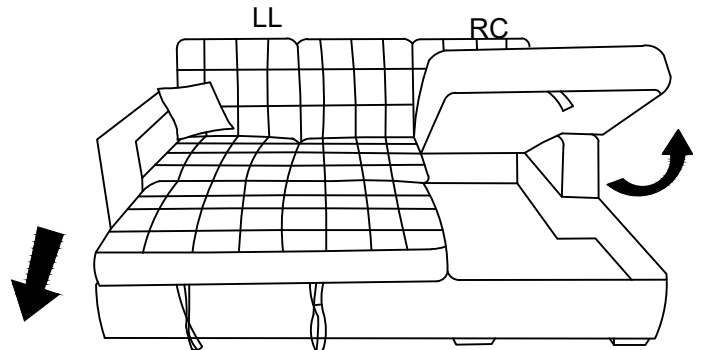
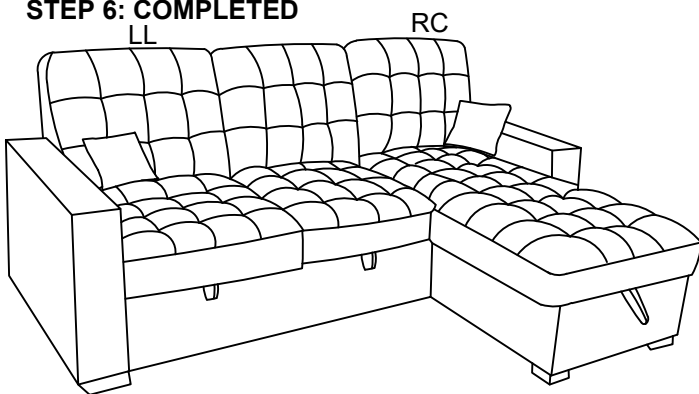

Care Instruction for Textured Furniture:

In order to maintain the original appearance of your Textured Furniture, please follow below simple care procedures:

- Avoid exposing furniture directly to sunlight or heating and air conditioning outlets. Sunlight and or exposure to heating and air conditioning outlets will fade/damage Textured.
- Vacuum or wipe with a soft cloth to remove dust.
- Hardware may loosen over time. Periodically check to make sure all connection are tight, Re-tighten if necessary.



For items use on wooden floor, hard surfaces or carpets, it is recommended to Install protective pads under all legs and supports to avoid/prevent from damages/scratches and discoloration.