

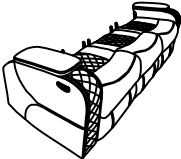





# ASSEMBLY INSTRUCTIONS

ITEM NO :.SH8895BLK-3/SH8895GRW-3 / SH8895RED-3  
 POWER DOUBLE RECLINER SOFA W/  
 DROP-DOWN CUP HOLDER, POWER HEADRESTS &  
 LED LIGHT/SPEAKERS

NOTE: Do not use power tools for assembly. Power tool increase the risk of over tightening which lead to splitting or cracking the wood.

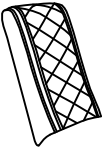
## PARTS LIST

NO.	DRAWING	DESCRIPTION	QTY
A		SEAT WITH WIRE	1PC
B		LSF BACK REST	1PC
C		MIDDLE BACK REST	1PC
D		RSF BACK REST	1PC
E		LSF EAR	1PC
F		RSF EAR	1PC

## HARDWARE LIST

NO.	DRAWING	DESCRIPTION	QTY
1		PLUG ADAPTER WITH WIRE	1PC

Please follow the below drawings to assemble the item.

### STEP 1

Align the female brackets at the back onto the male brackets at the seat, insert back rest to the seat then push to the end and make sure it is fixed in position securely. Connecting the wire from back rest to seat for power headrest and receptacle outlet.

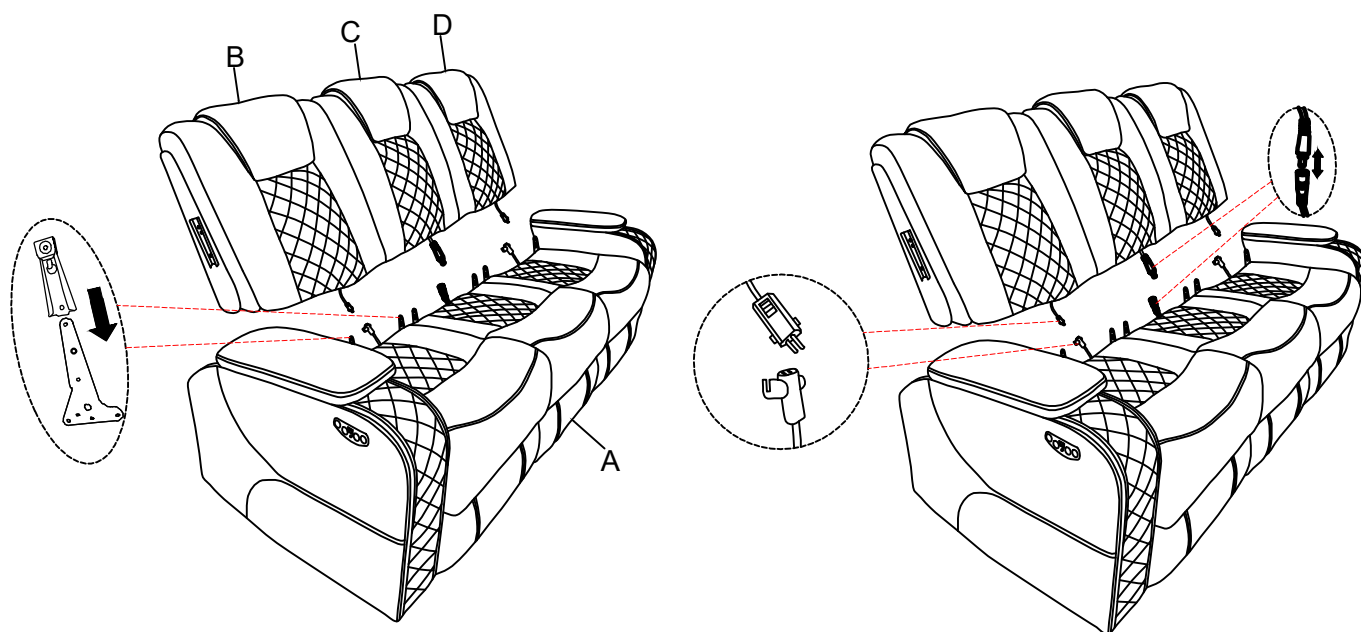

### STEP 2

Insert ear to the backrest then push to the end and make sure it is fixed in position securely.

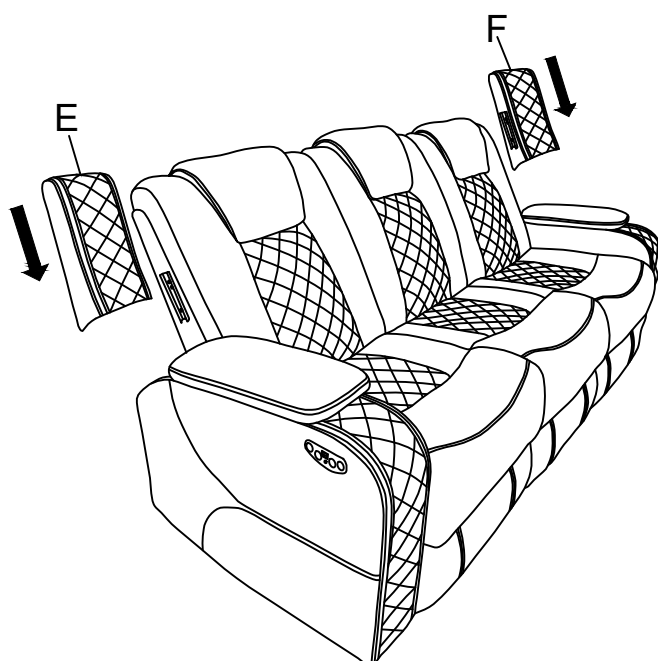

Please follow the below drawings to assemble the item.

### STEP 3

Carefull allign & connect the plug with wire (1)(2) to the slot. make sure it connect with securely.

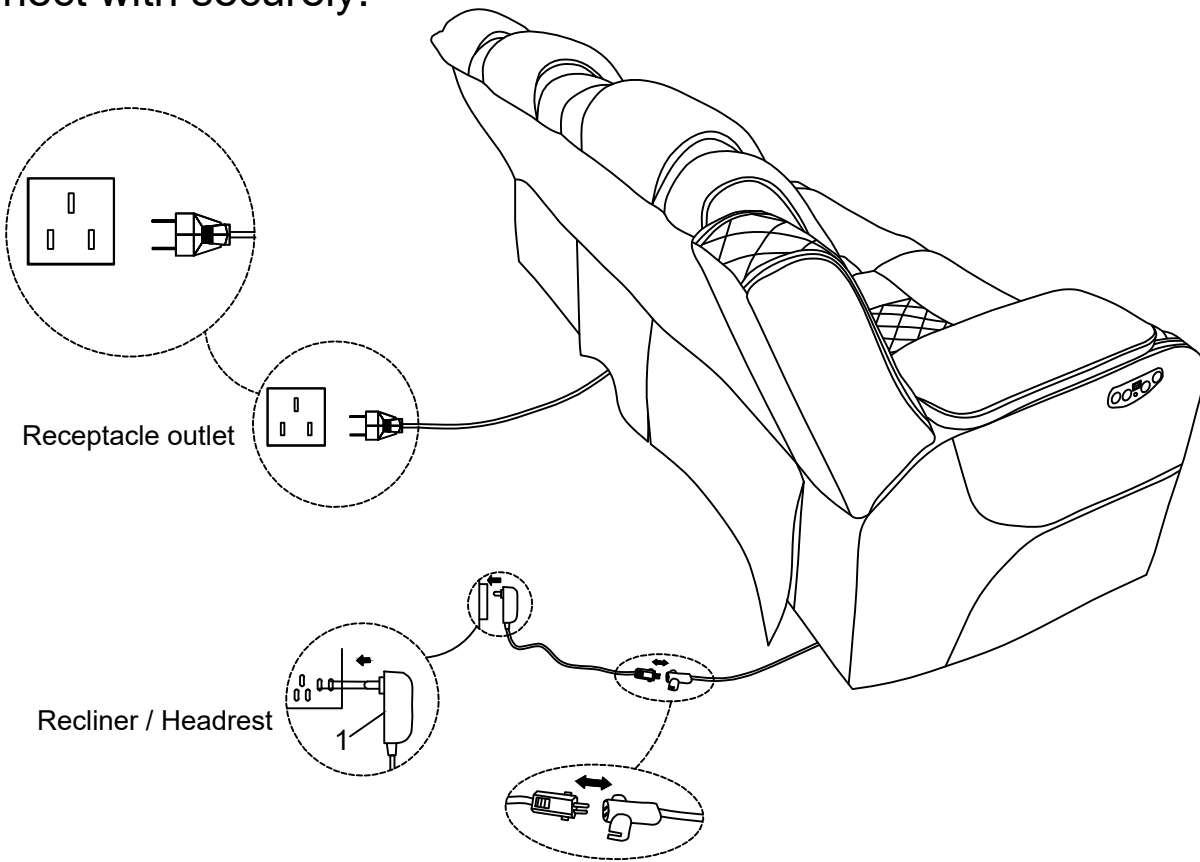

### STEP 4

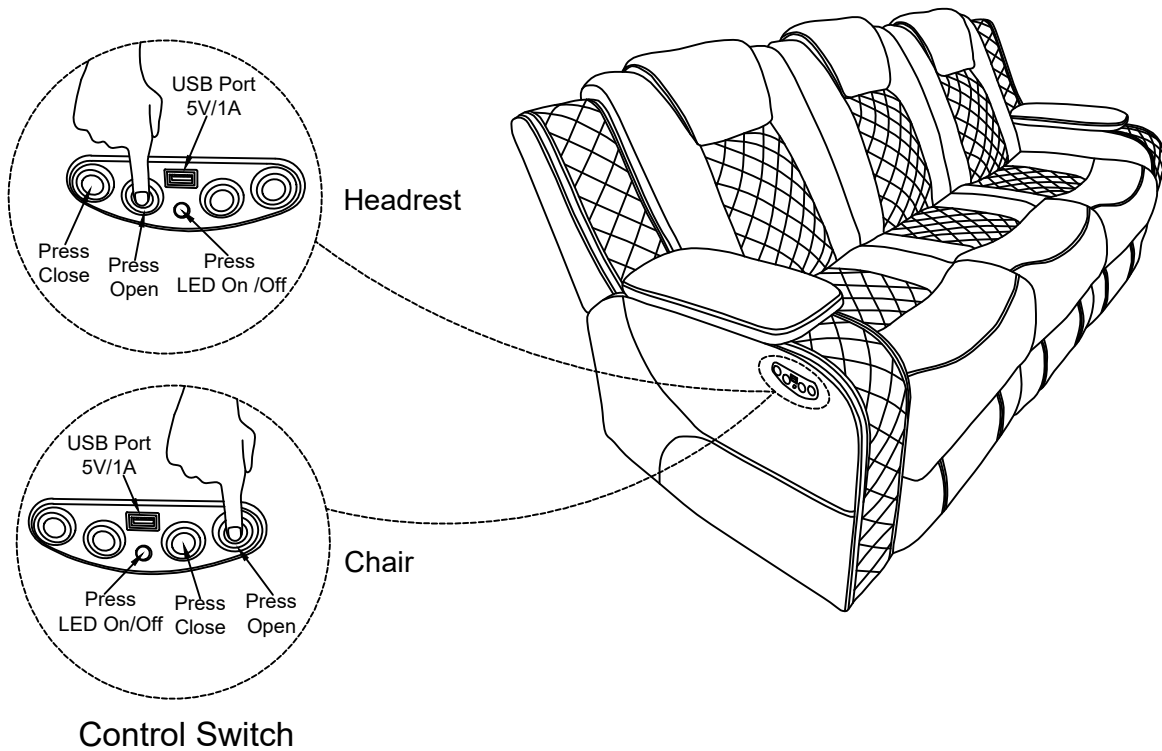

Please follow the below drawings to assemble the item.

### STEP 5

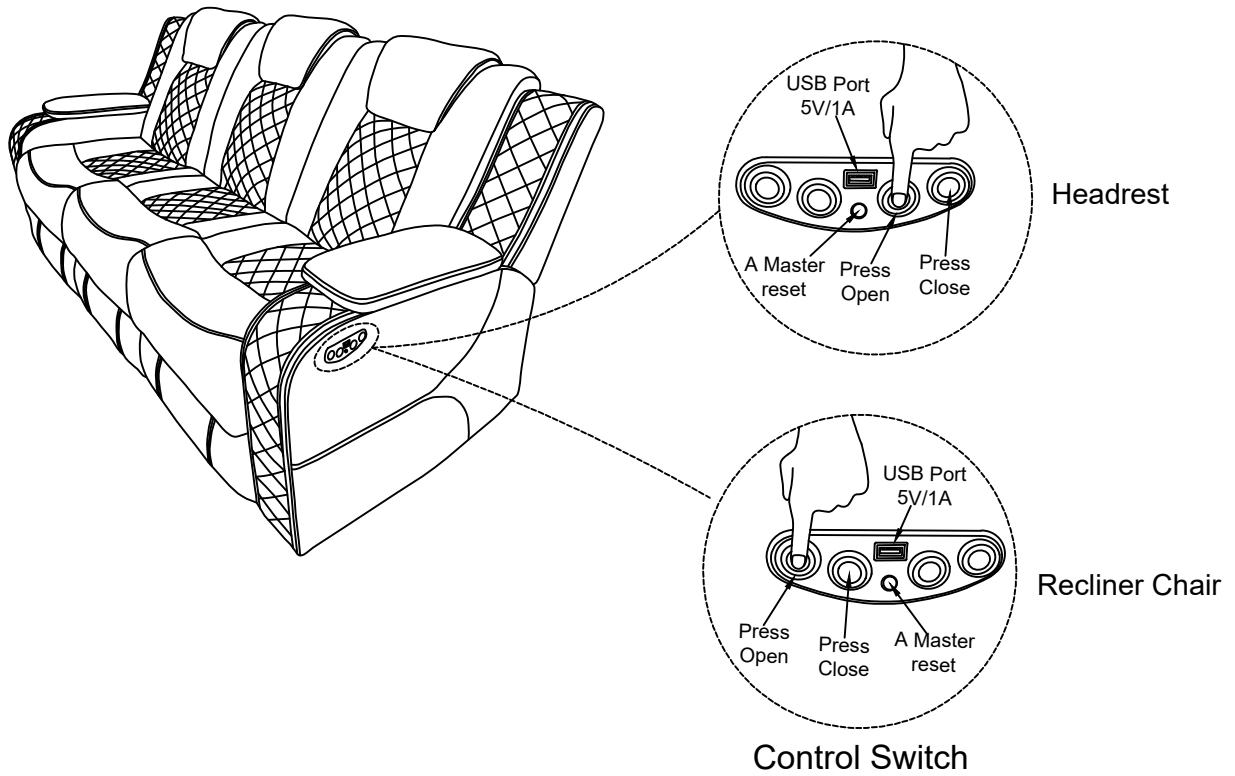

### STEP 6

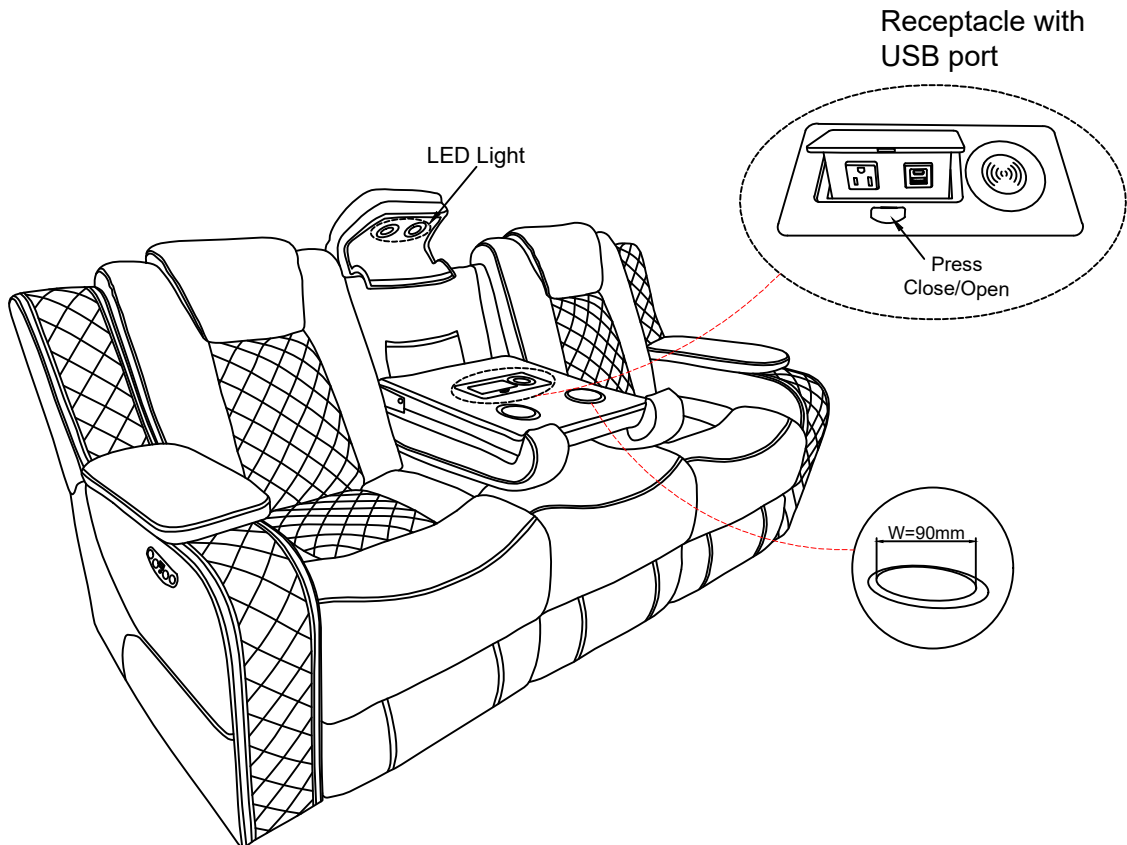

Completed.

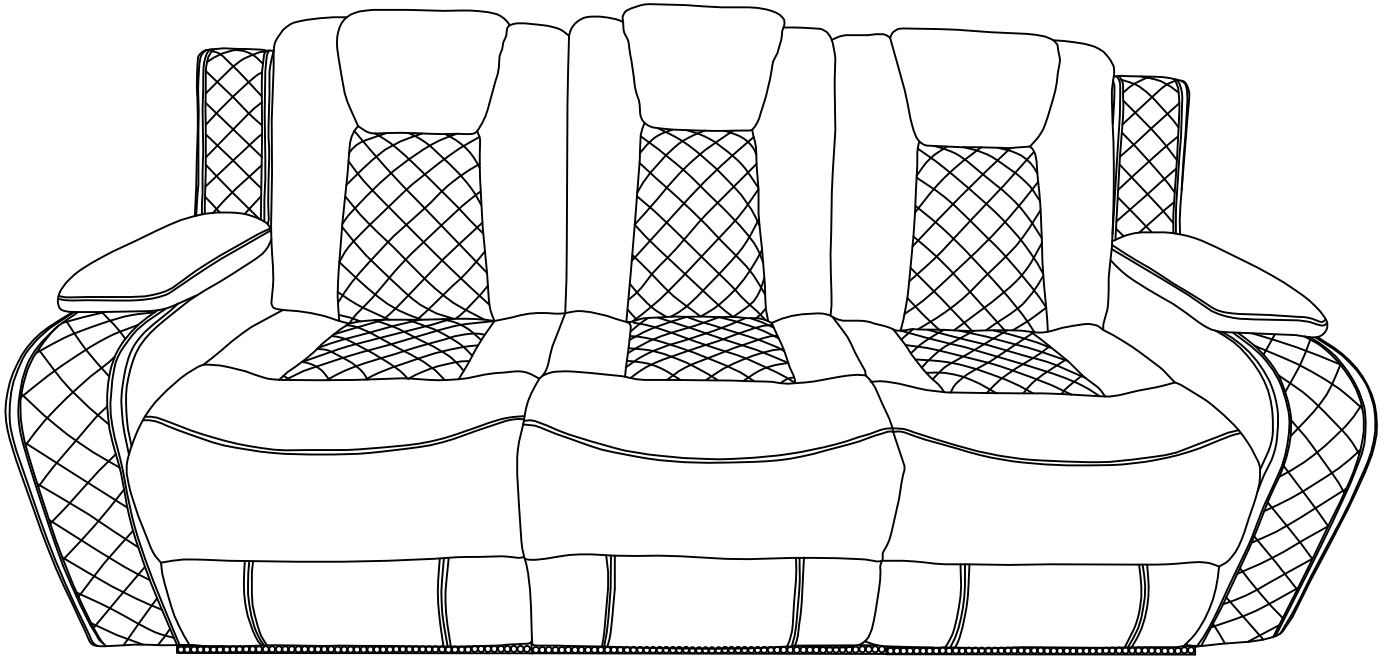

## CARE INSTRUCTION FOR POLYESTER

In order to maintain the original appearance of your polyester furniture, please follow below simple care procedure:

- Avoid exposing furniture directly to sunlight or heating and air conditioning outlets. Exposure to sunlight or heating and air conditioning outlets will fade/damage polyester.
- Wipe gently with a damp soft cloth to remove dust dirt and any grime build up.

### WARNING

- Disconnect the electrical plug from the wall outlets before cleaning, moving, servicing or when not in use for an extended period of time.
- Plug directly into a wall outlet. Do not use an extension cord or adaptor.
- Check the condition of the power transformers, electrical cords, plugs and connectors monthly. Keep the power adapter and electrical cords away from heat sources. Never operate the unit with a damaged power adapter, electrical cord, plug or connector.
- Before moving the product, please disconnect the electrical plug from the wall outlet and secure the mechanism to prevent unexpected opening or movement. Never move the product by the mechanism, legrest, handle, or reclining back.
- Do not attempt to disassemble or service the adaptor or motor. No serviceable parts are inside.
- Do not allow electrical cord to be pinched between moving parts or between the frame and the floor. Do not place cord under carpet or in location where it could become worn.
- Unplug the power cord immediately if you detect strange odors or fumes coming from the chair.

PLEASE KEEP ASSEMBLY INSTRUCTION FOR FUTURE REFERENCE