

Assembly Instructions

ITEM: SH3413

Power Left Arm Recliner, power headrest

Power Right Arm Recliner, power headrest

Power Armless Chair Recliner, power headrest

Armless Chair

Corner Wedge

Console

SKU:

SH3413SAD-LRPWH SH3413SAD-RRPWH SH3413SAD-ARPWH

SH3413SAD-AC SH3413SAD-CR SH3413SAD-CN

SH3413GRY-LRPWH SH3413GRY-RRPWH SH3413GRY-ARPWH

SH3413GRY-AC SH3413GRY-CR SH3413GRY-CN

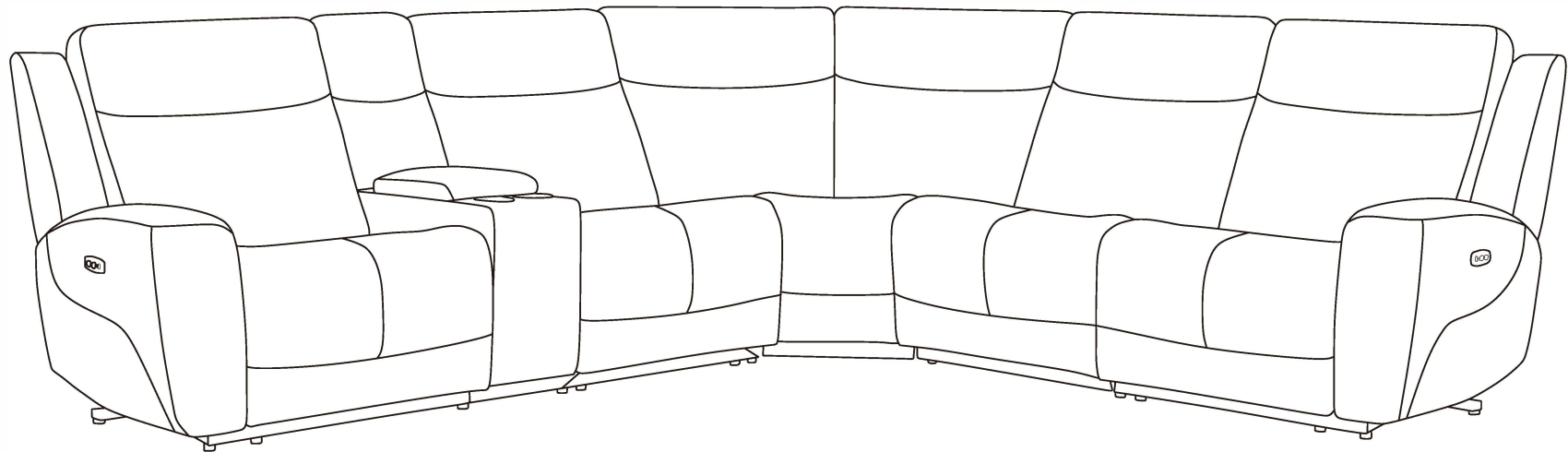

Preparations

Pre-Assembly Preparations

Thank you for choosing our product, please read this instruction carefully before assembly.

First, to avoid damage to the product, please make sure you have a large and clean place to assemble. Second, please check all the parts according to the list on the next page.

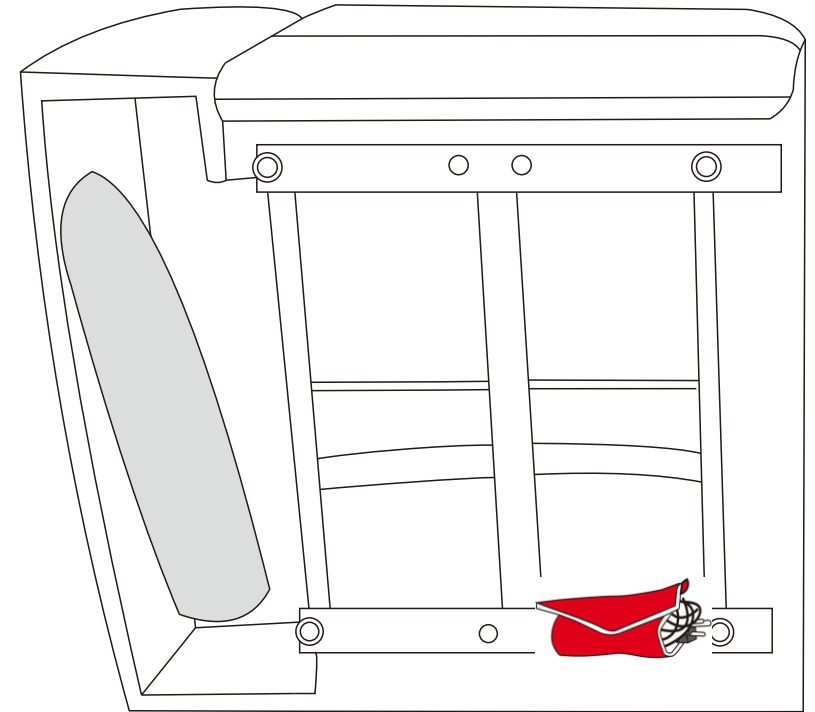

List of Parts

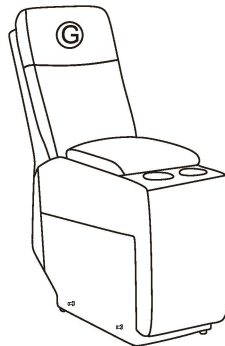
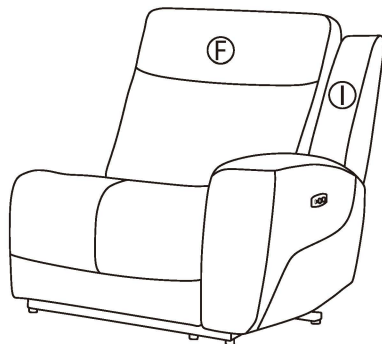
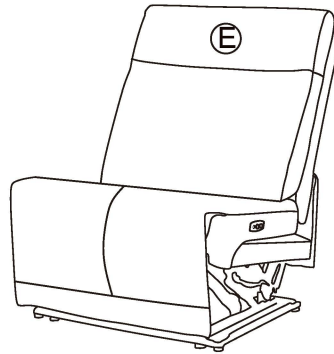
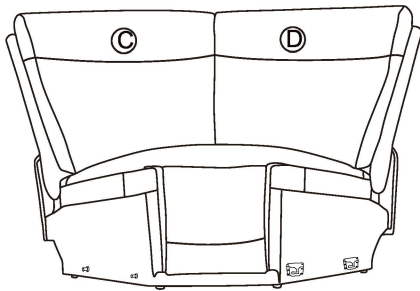
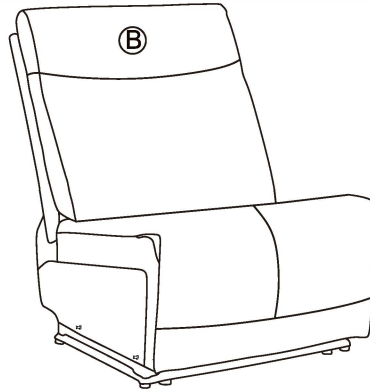
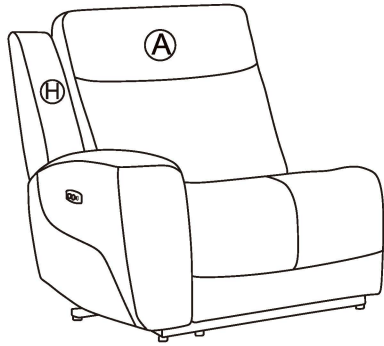

List of Parts

| NO. | Schetch | DescriptionBack | QTY |
|-----|---------|------------------------|-----|
| A | | Back(L) | 1 |
| B | | Back(Armless Chair) | 1 |
| C | | Back (Corner L) | 1 |
| D | | Back (Corner R) | 1 |
| E | | Back(Armless Recliner) | 1 |
| F | | Back (R) | 1 |
| G | | Back (Console) | 1 |
| H | | Wing(L) | 1 |
| I | | Wing(R) | 1 |

ASSEMBLY INSTRUCTIONS

STEP 1 Attaching the Backrest to the Body

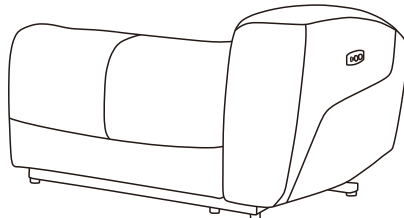
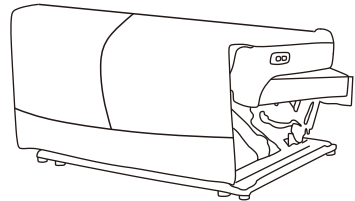
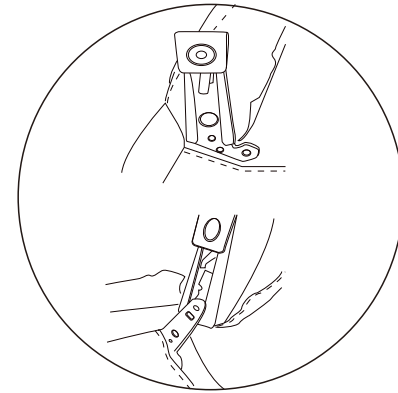
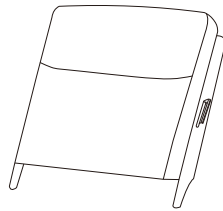
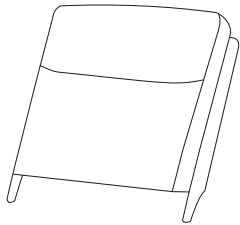
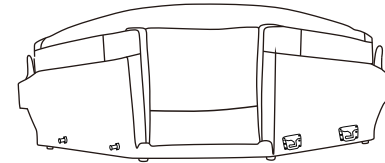
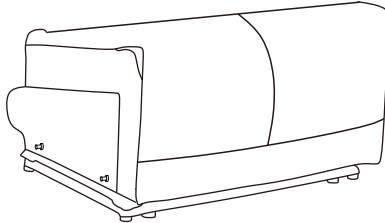
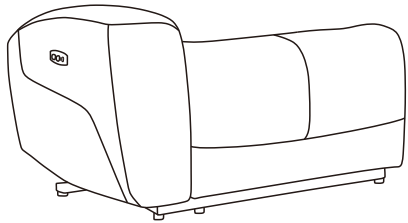
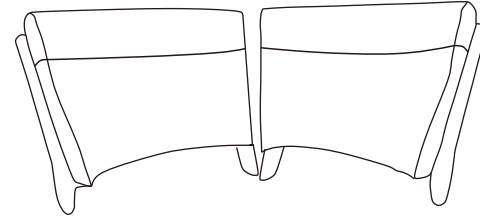
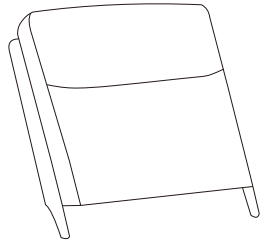
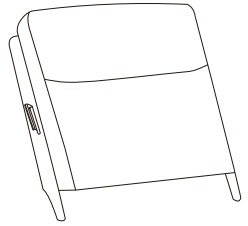

Please align the connectors of the backrest and seat according to the diagram, then press down to ensure a perfect fit.

ASSEMBLY INSTRUCTIONS

STEP 2

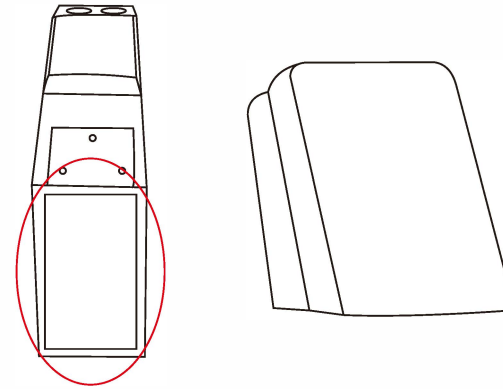
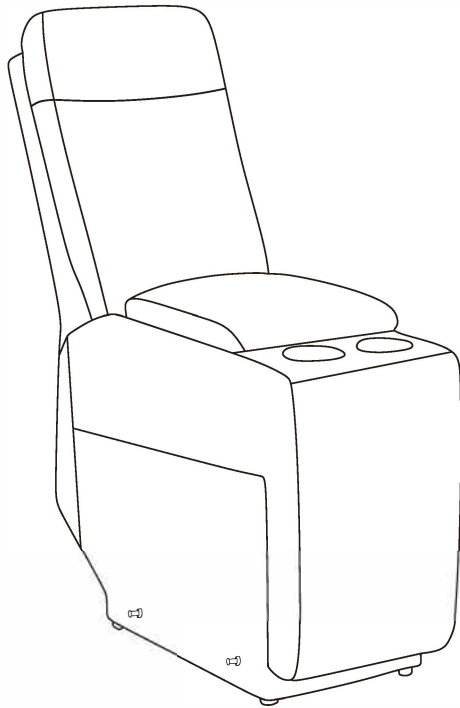

Please take out the Back(Console) from the bottom of the console.
Align the holes of the Back and console,
then tighten the screws in a clockwise direction.

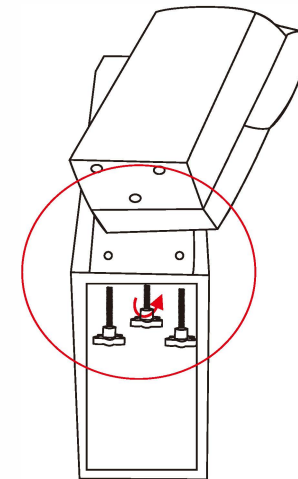

ASSEMBLY INSTRUCTIONS

STEP 3

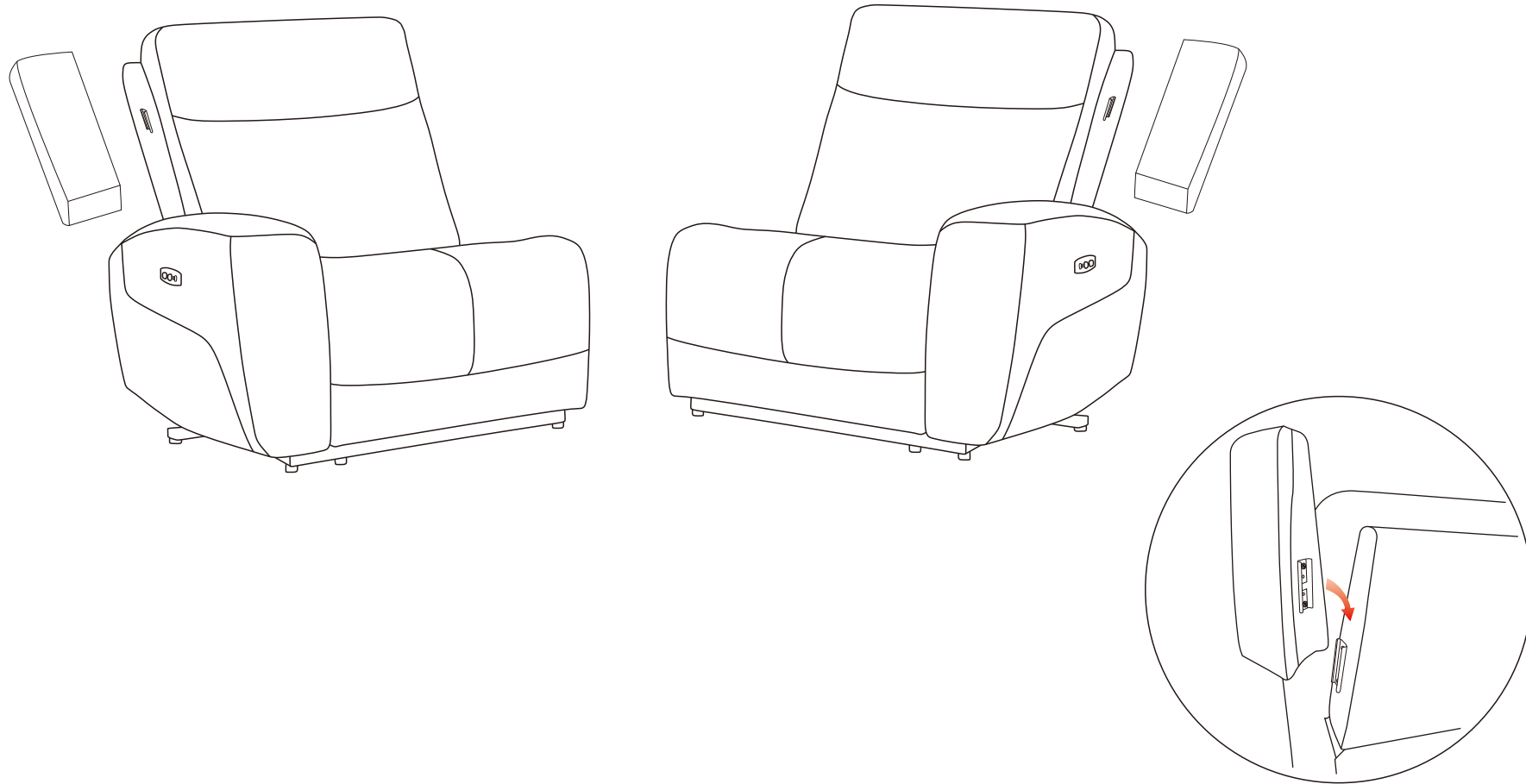

Please connect the backrest and the wing according to the diagram.

ASSEMBLY INSTRUCTIONS

STEP 4/5/6

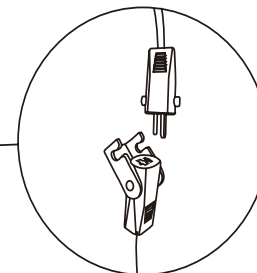
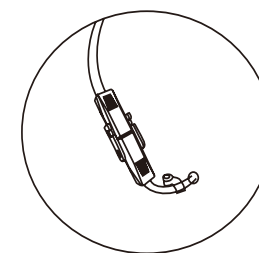
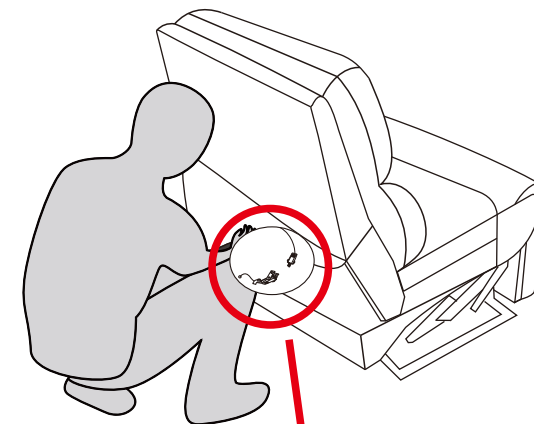
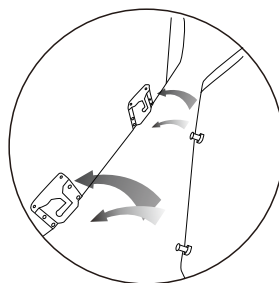
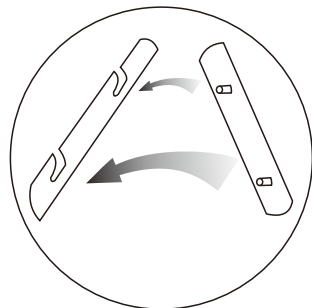
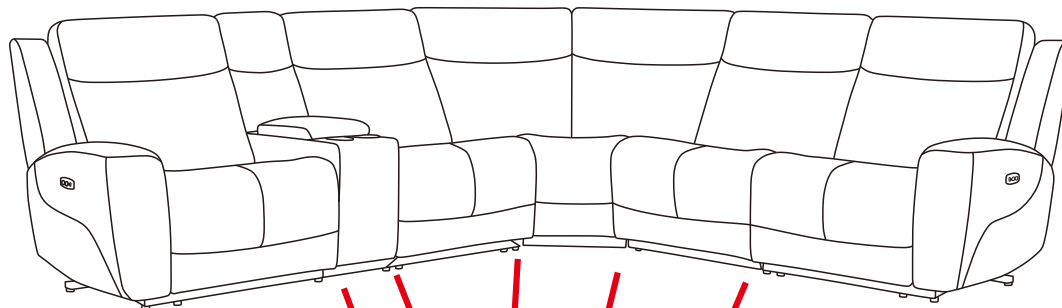

Align the connectors and connect all the items together, according to the diagram, then press down to ensure a perfect fit. Please be careful to avoid the damage to the sofa.

Please check and connect the power port of seat motor and headrest motor, make sure secure the protector.

ASSEMBLY INSTRUCTIONS

Fasten the Velcro

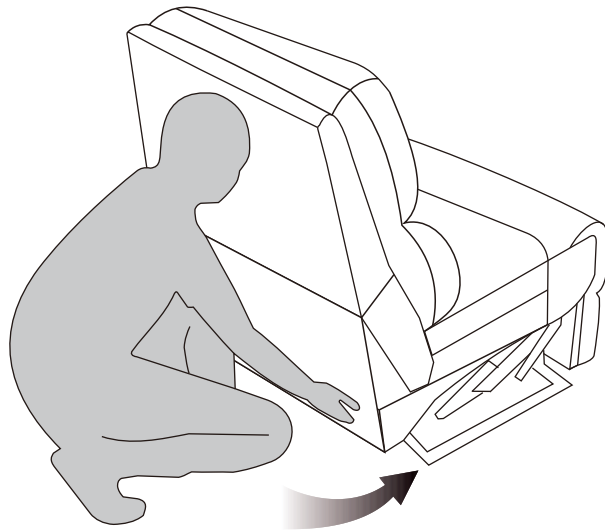

Attach the Velcro on the back of the sofa

Connect the power supply

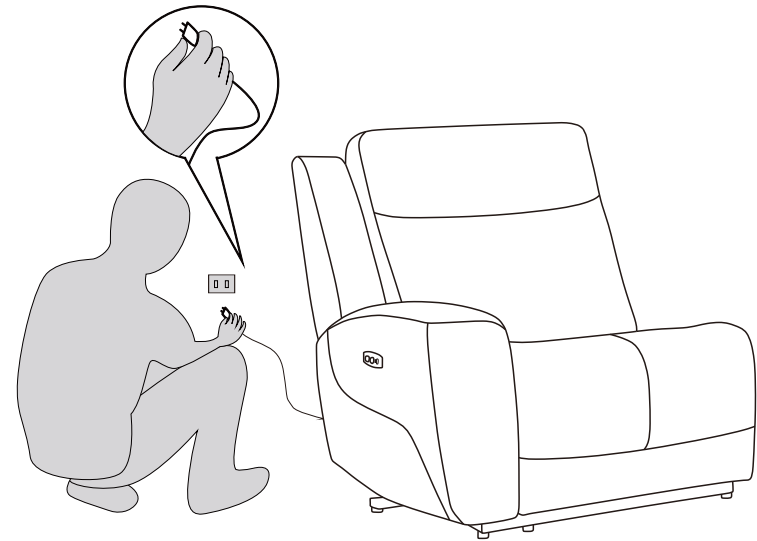

POWER CONNECTIONS

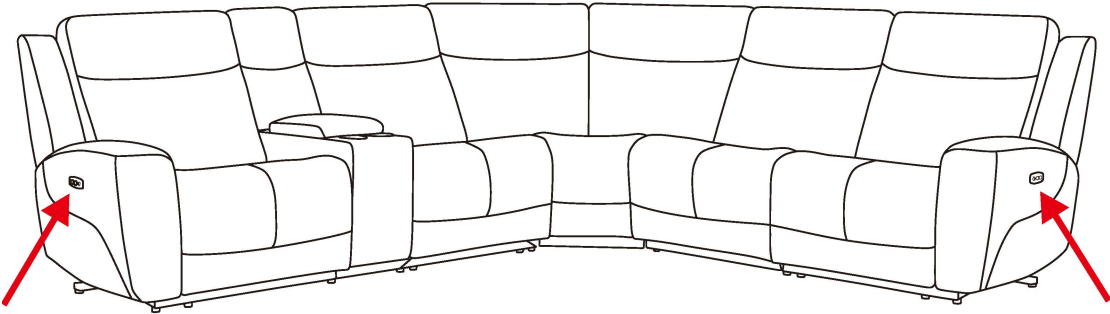
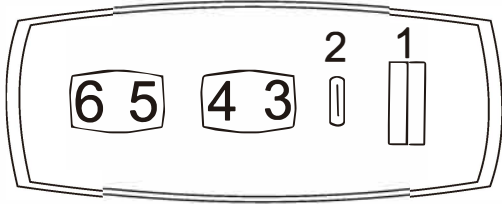

| Location | Function |
|----------|-------------------|
| 1 | USB Port |
| 2 | Type C |
| 3 | Seat Forward |
| 4 | Home Button |
| 5 | Headrest Forward |
| 6 | Headrest Backward |